

LAYOUT GUIDE

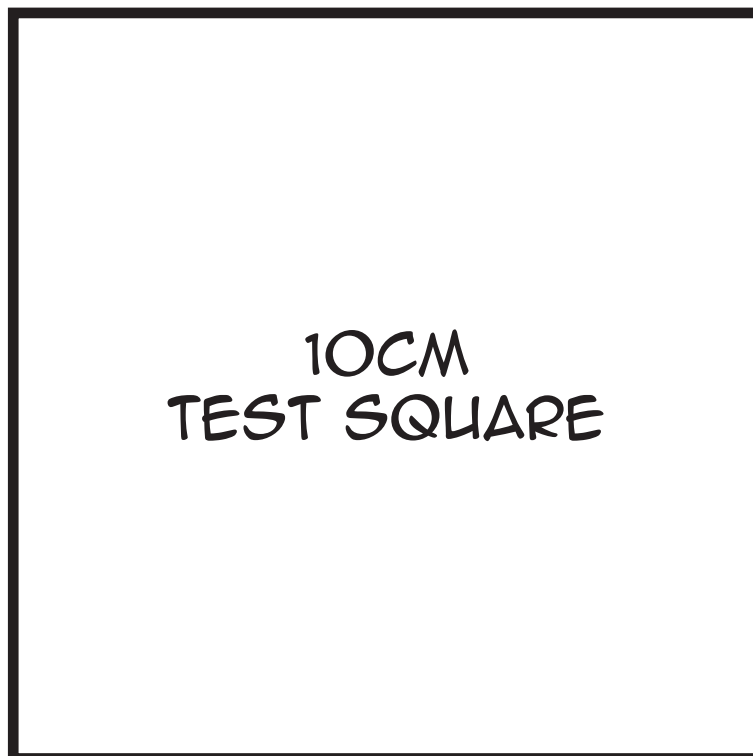

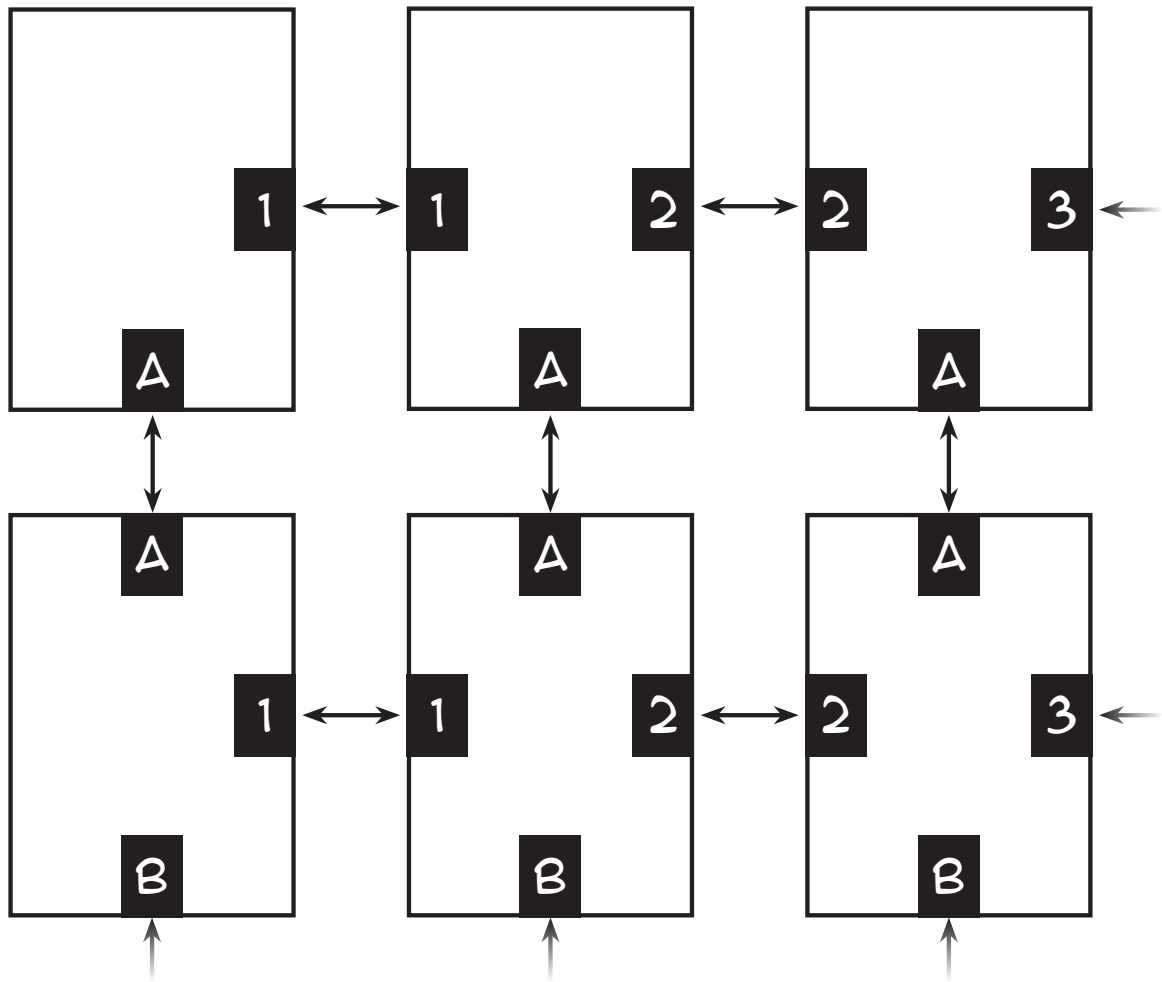

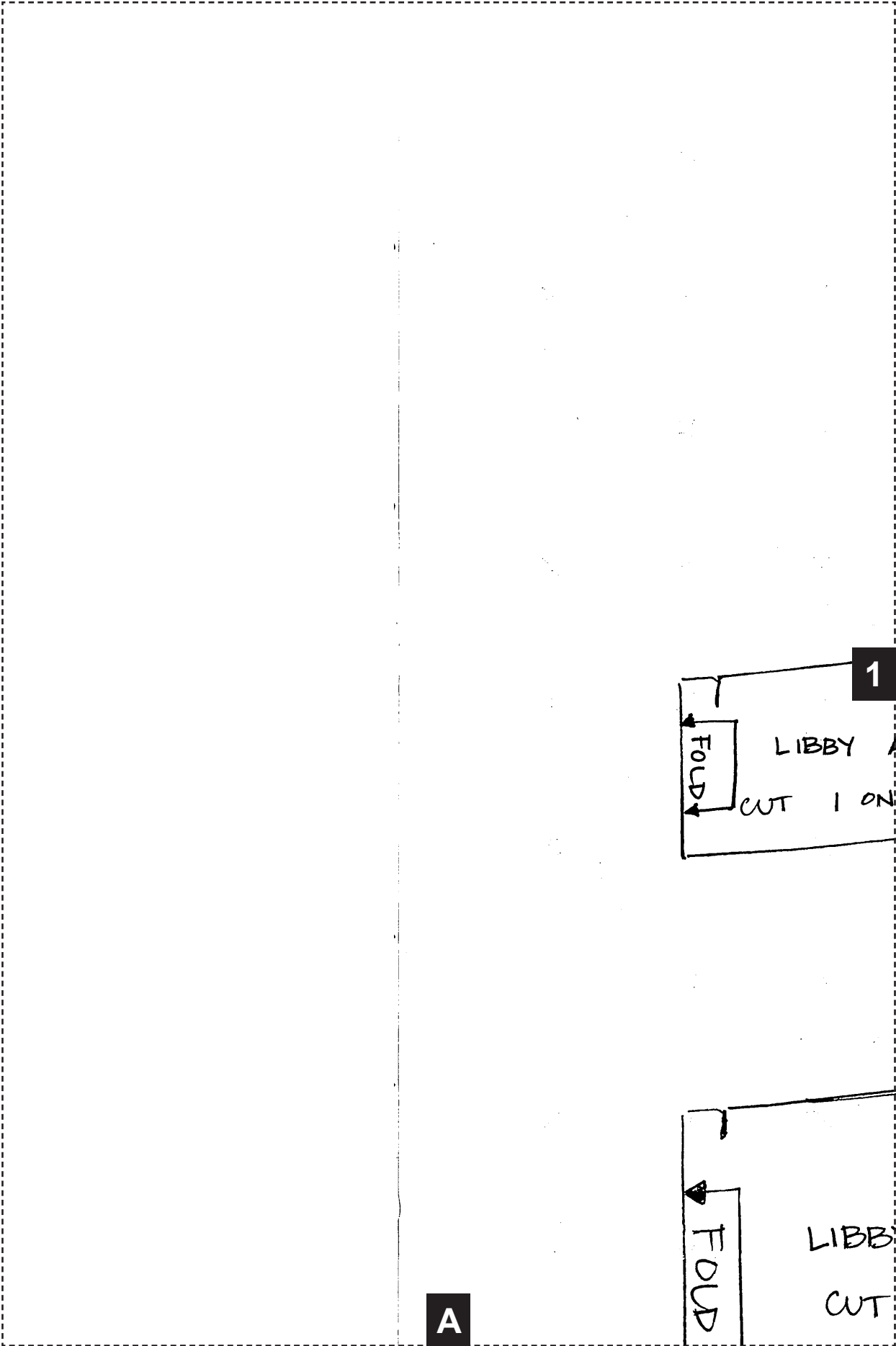
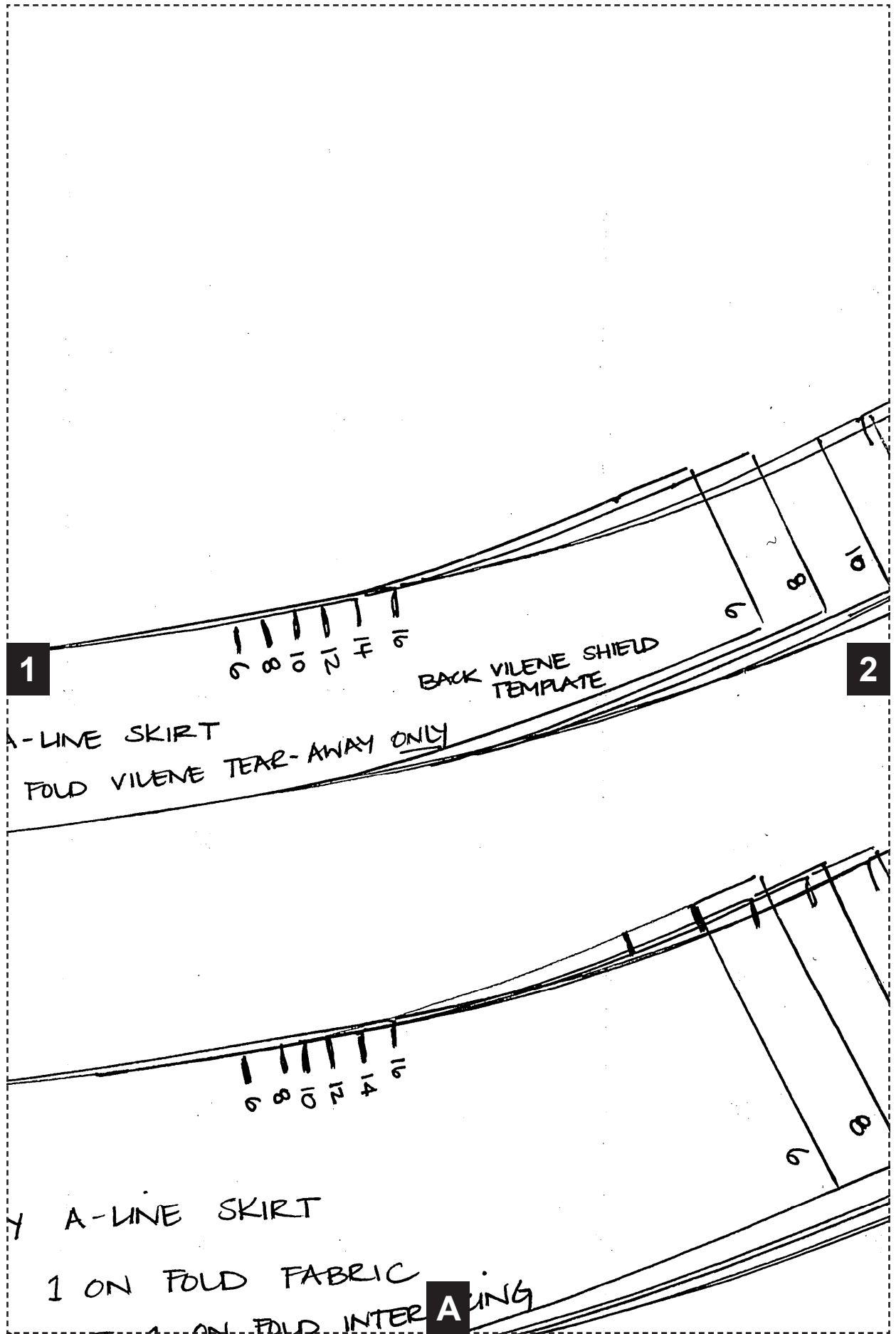

1

2

A-LINE SKIRT
 FOLD VILENE TEAR-AWAY ONLY

BACK VILENE SHIELD
 TEMPLATE

A-LINE SKIRT
 1 ON FOLD FABRIC
 1 ON FOLD INTER **A** LING

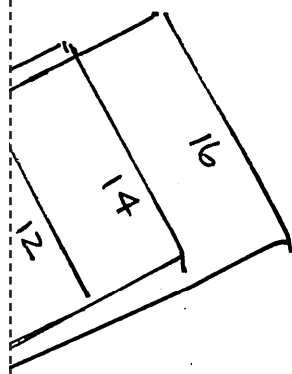

2

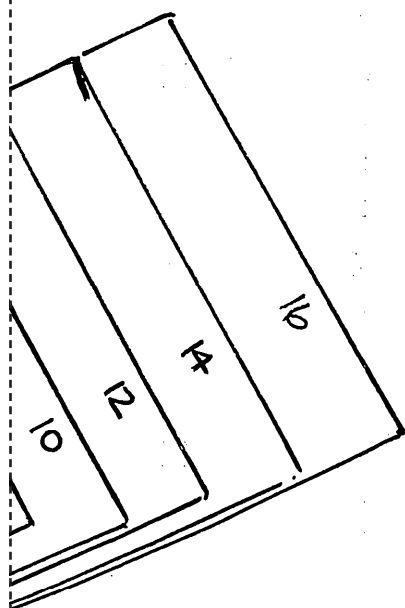

A

3

3

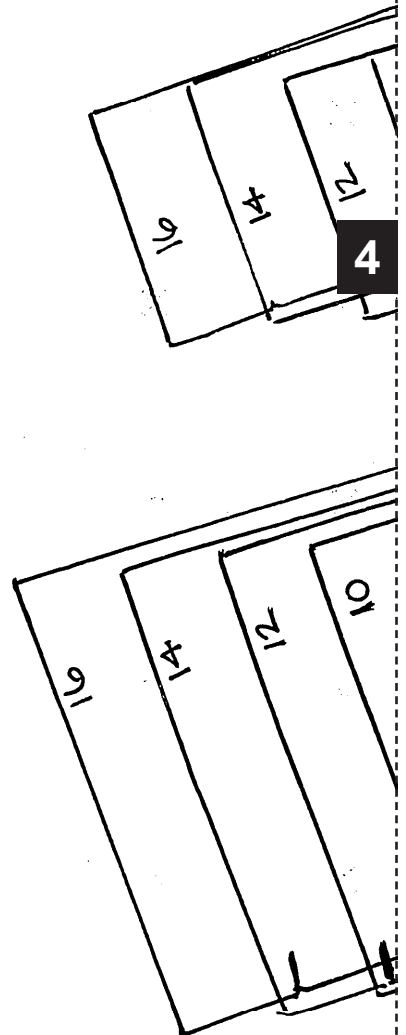

A

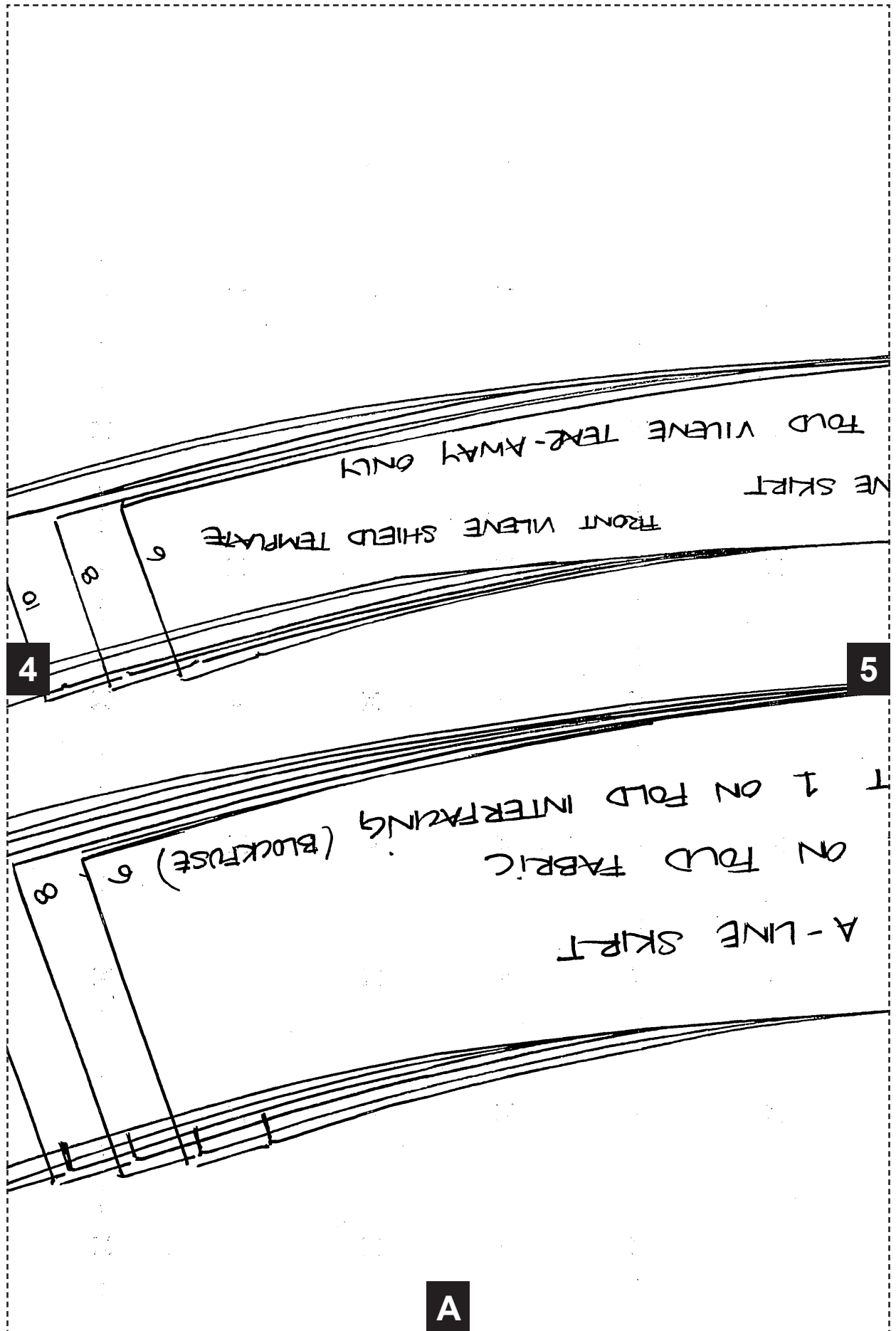

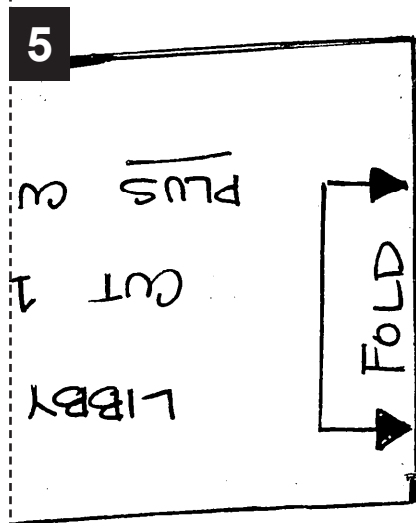
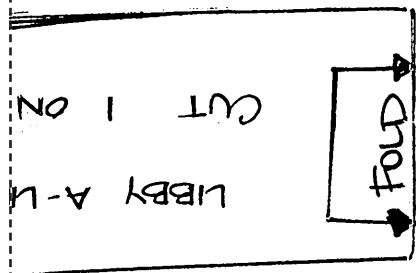

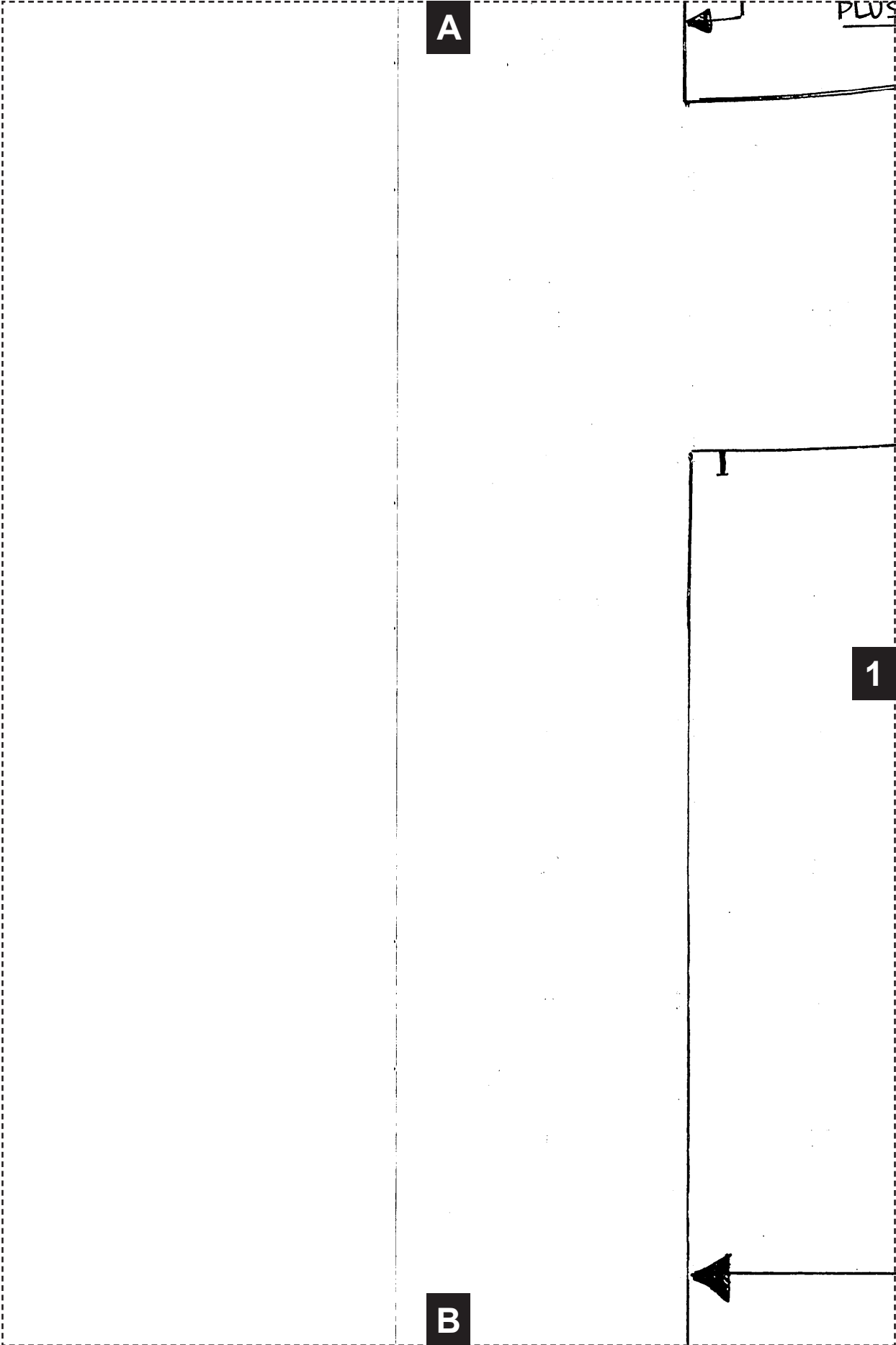

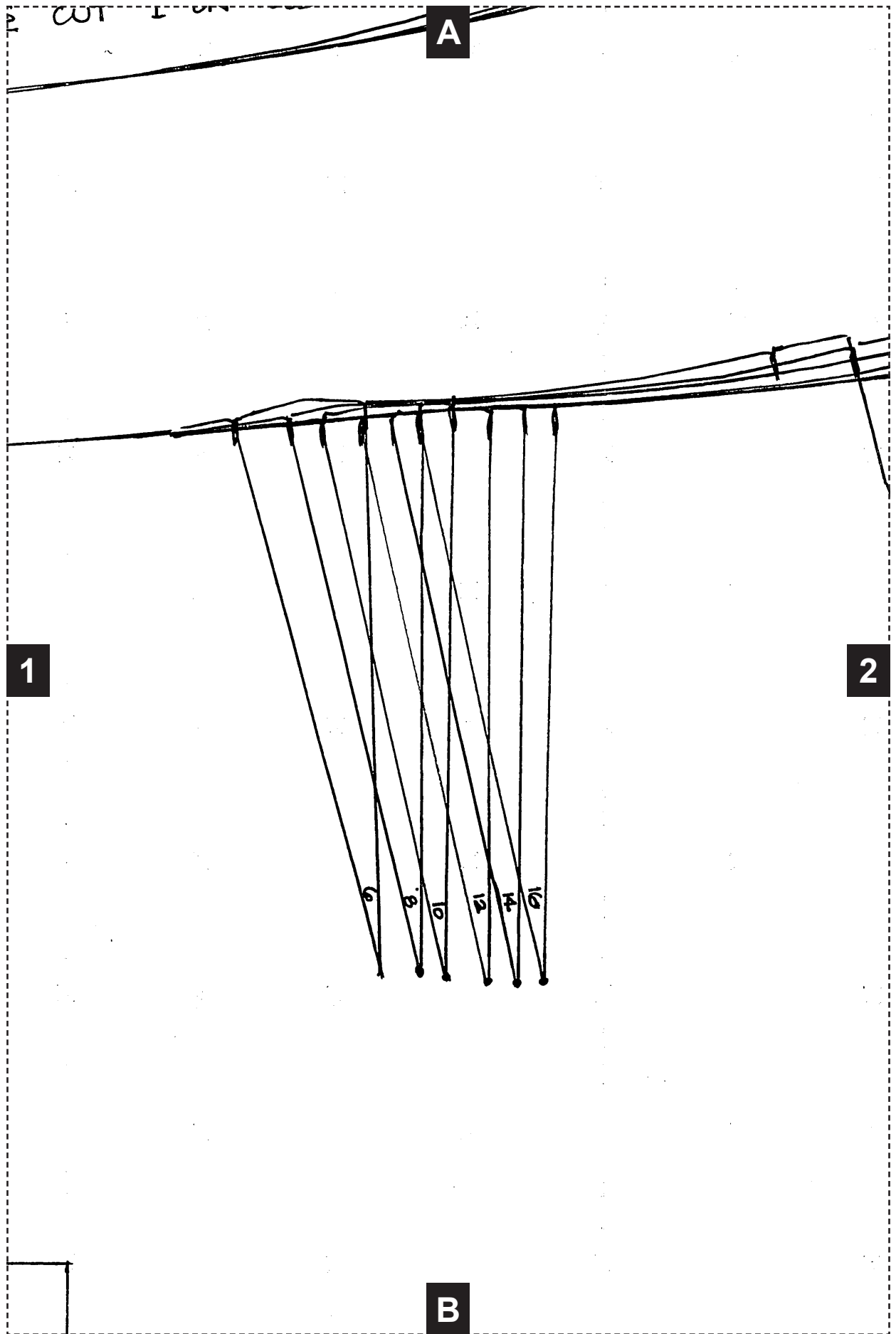

A

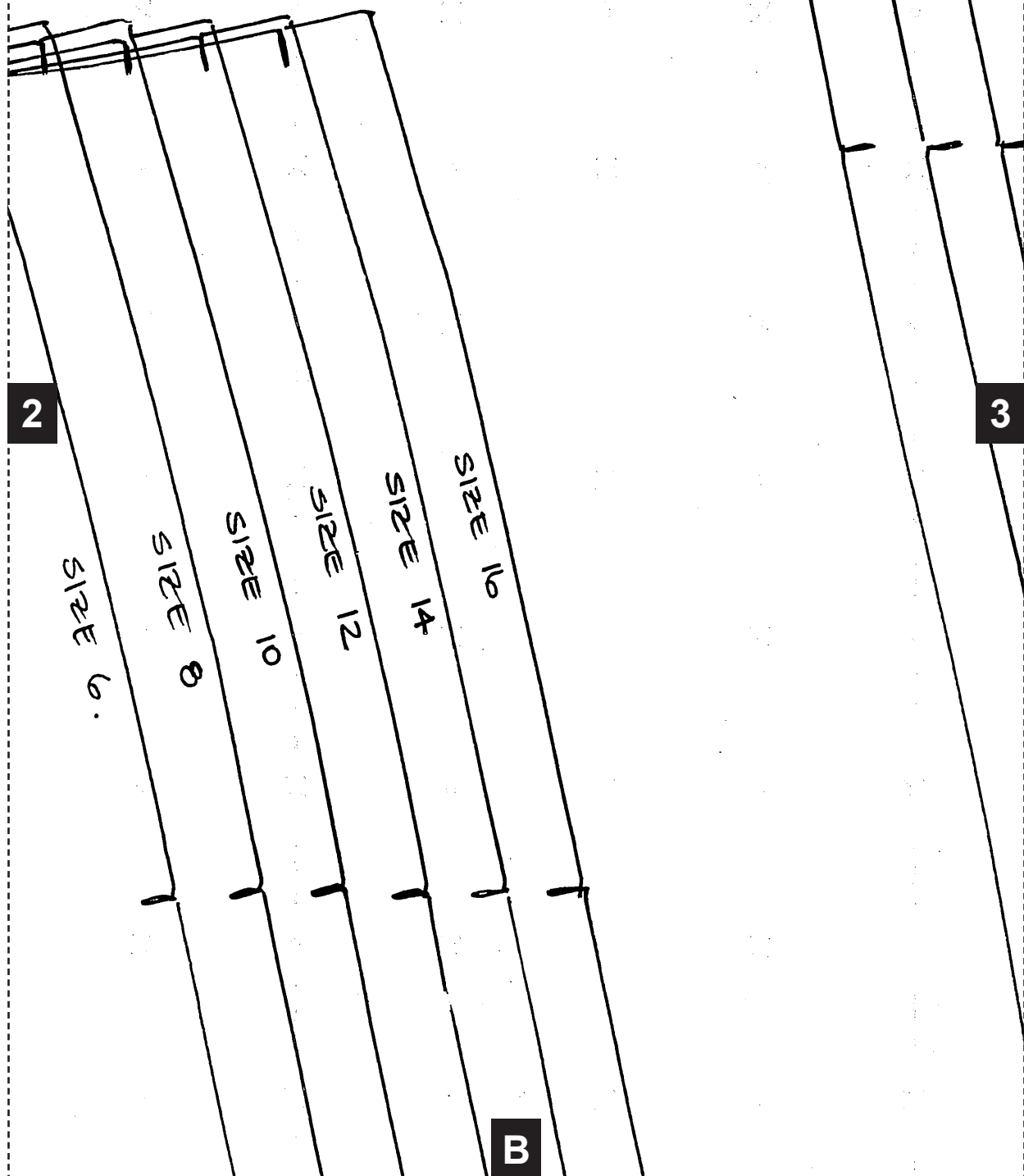

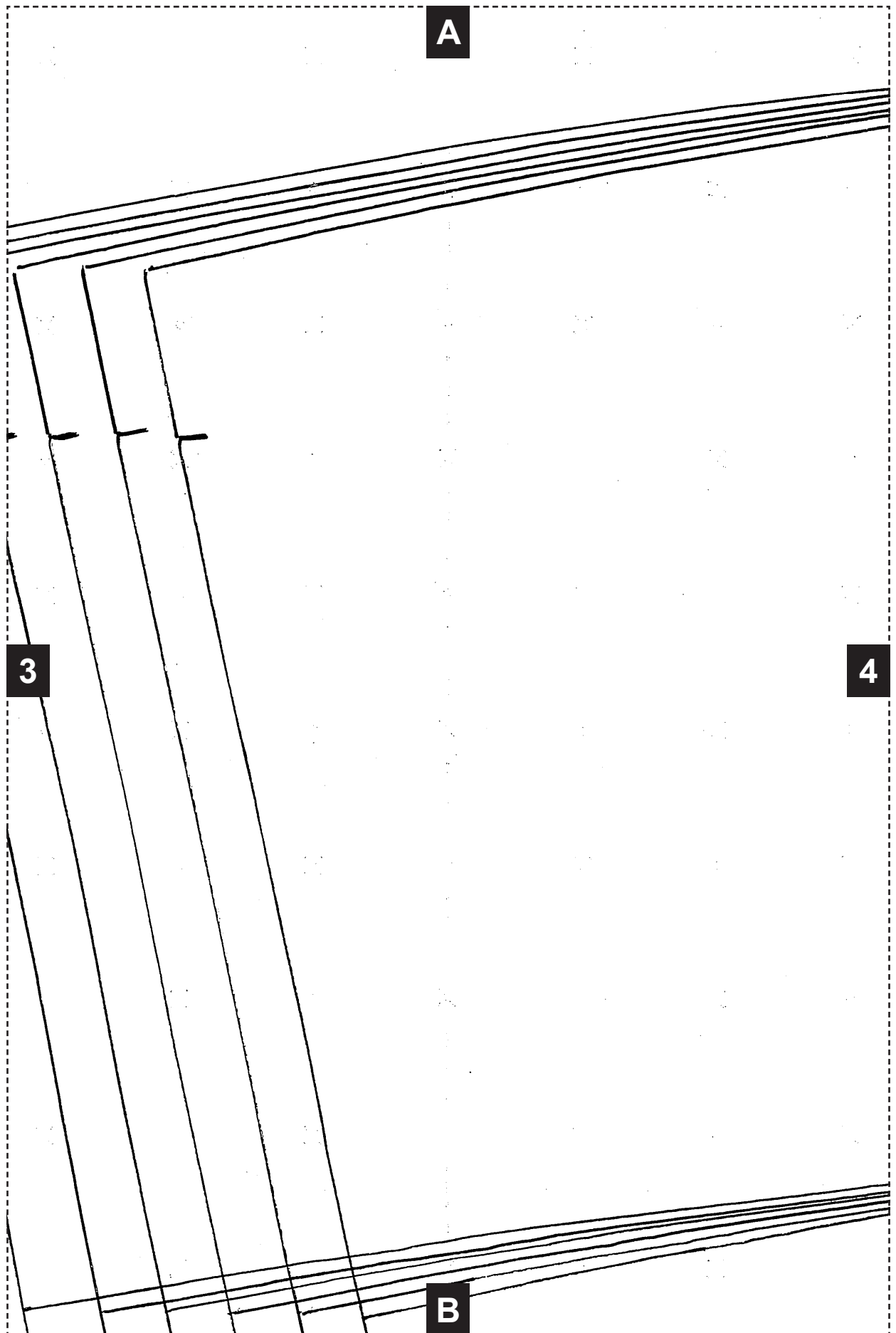

A

HERE FOR LONG LENGTH ↑

4

5

B

HERE FOR MID LENGTH ↑

↑ CUT TO

A

5

↑ CUT TO

B

1

CENTRE BACK FOLD



B

C

2

LIBBY A - LINE SKIRT

B

BACK

C

CUT 1 ON FOLD.

1

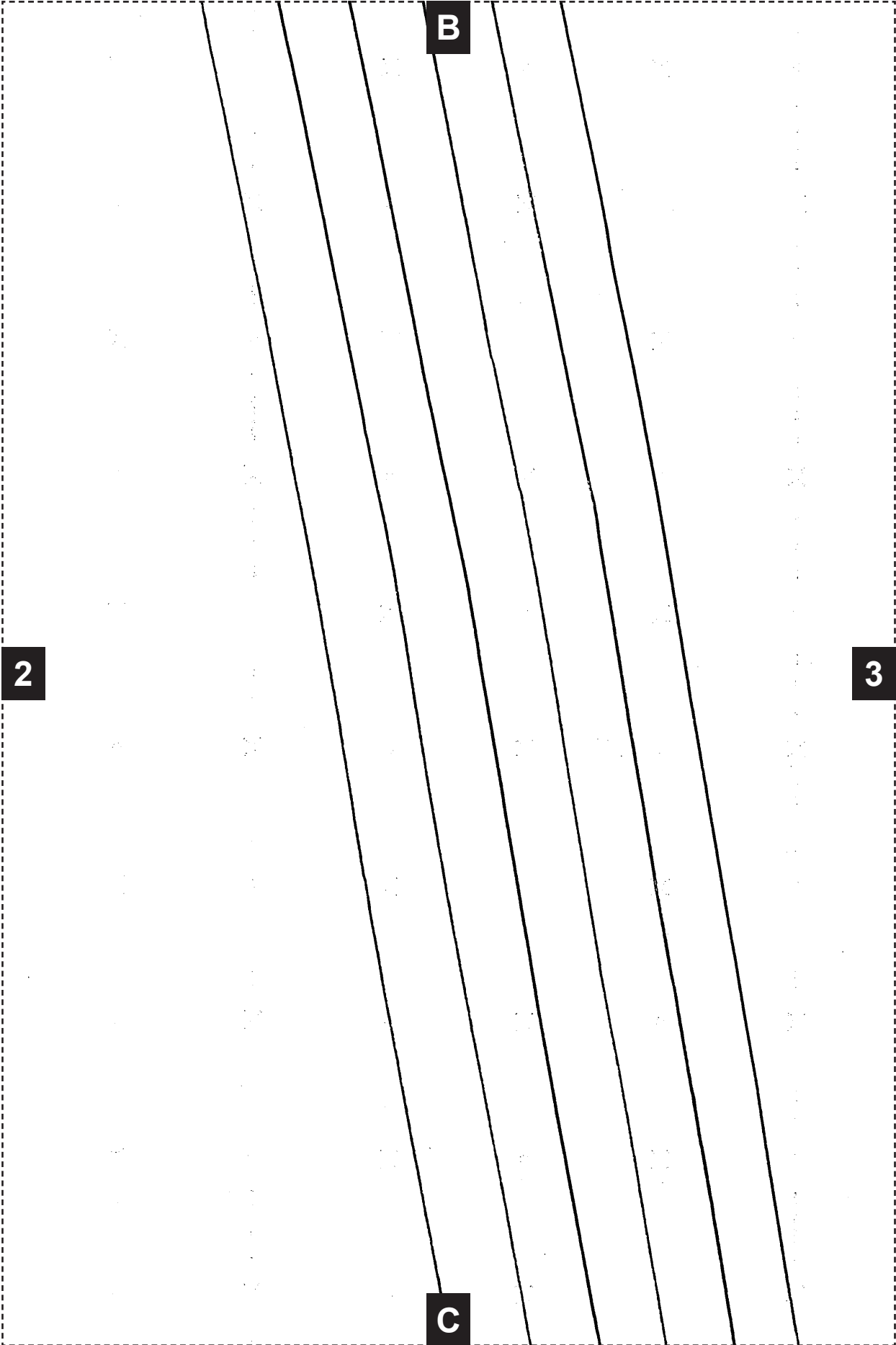

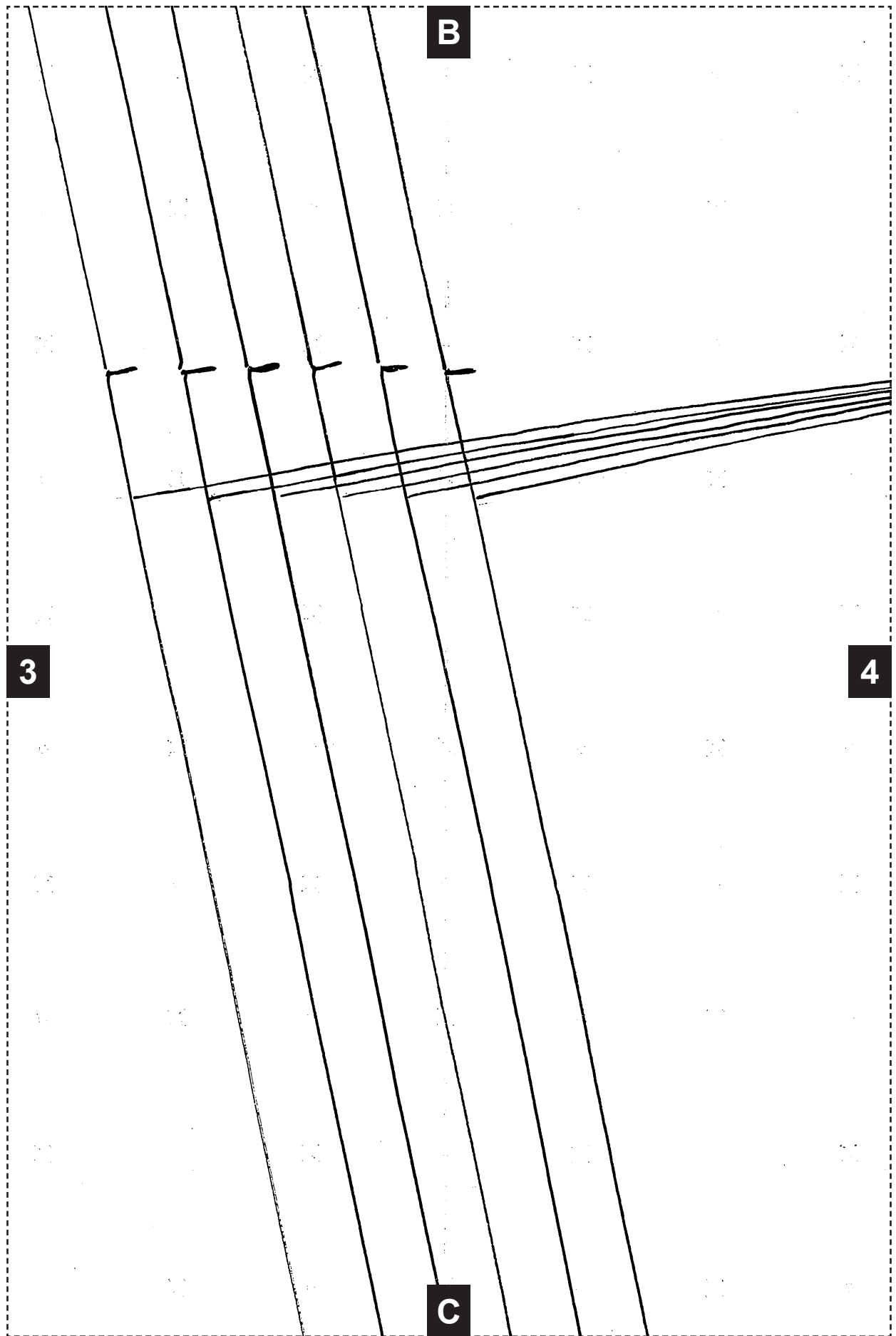

4

LIBBY A-LINE SKIRT

C

FRONT

CUT 1 ON FOLD

B

↑ for SHORT LENGTH

5

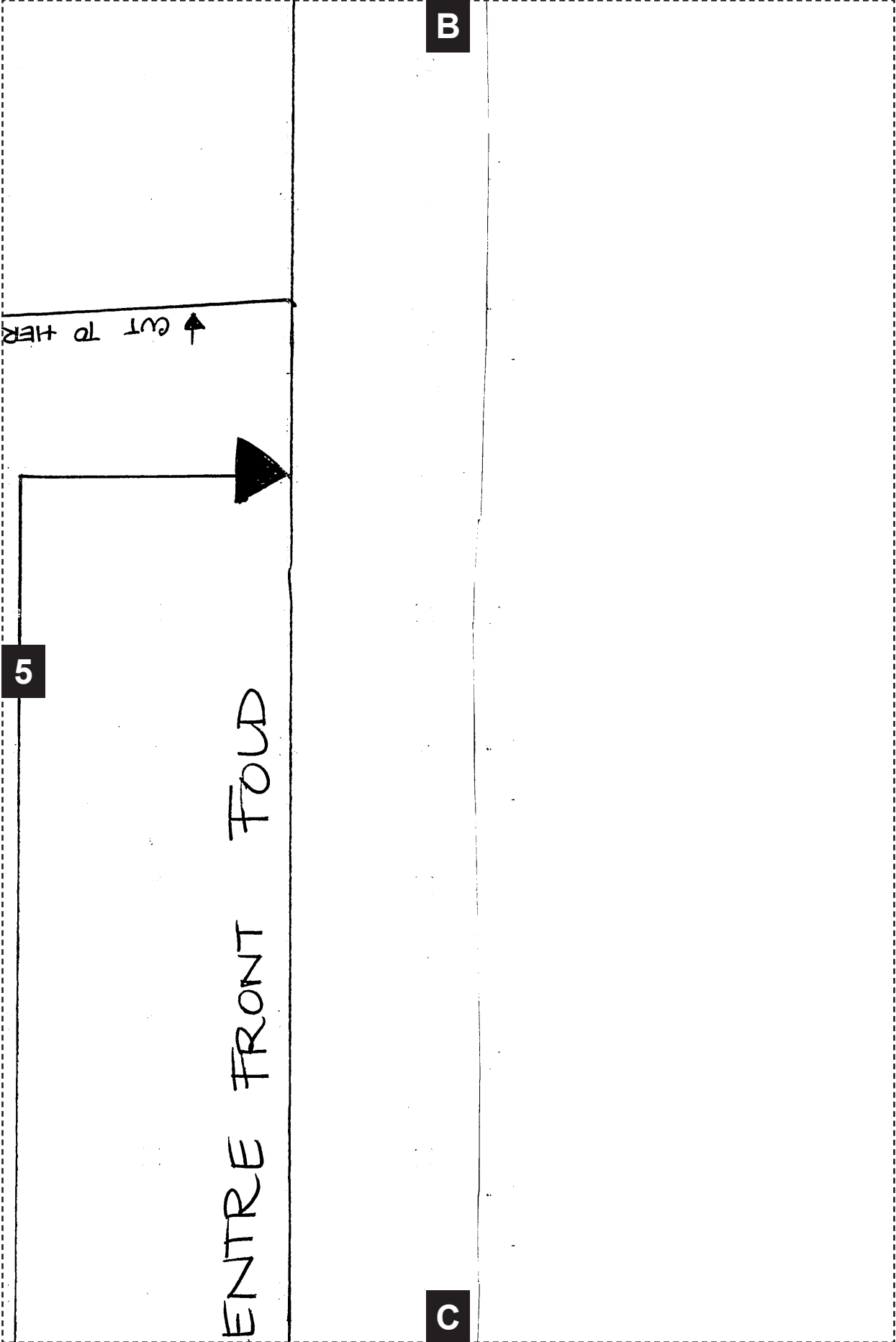

5

ENTRE FRONT FOLD

CUT TO HERE

B

C

C

↓ CUT T

1

↓ CUT T

D

C

HERE FOR SHORT LENGTH ↓

1

2

D HERE FOR MID LENGTH ↓

D

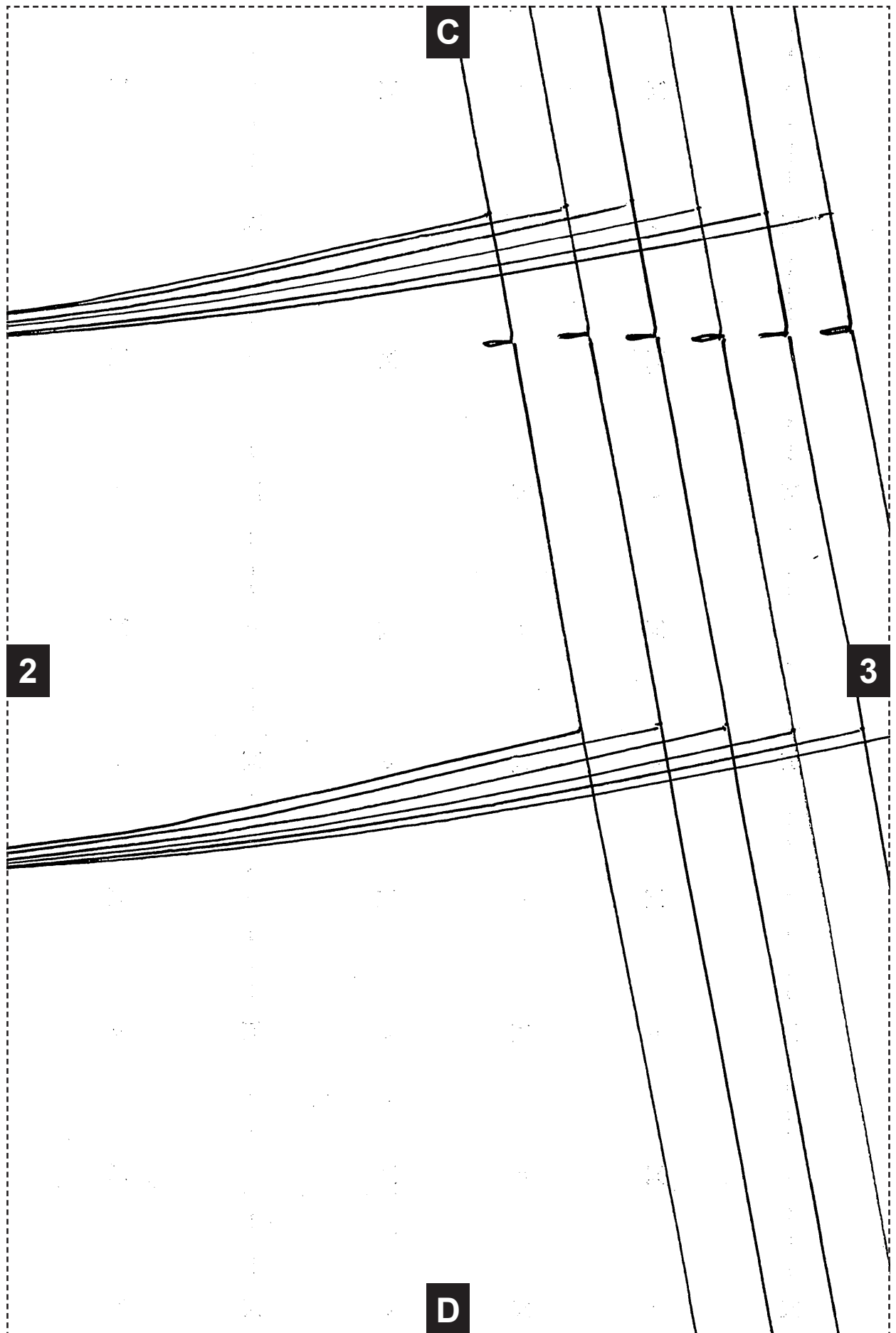

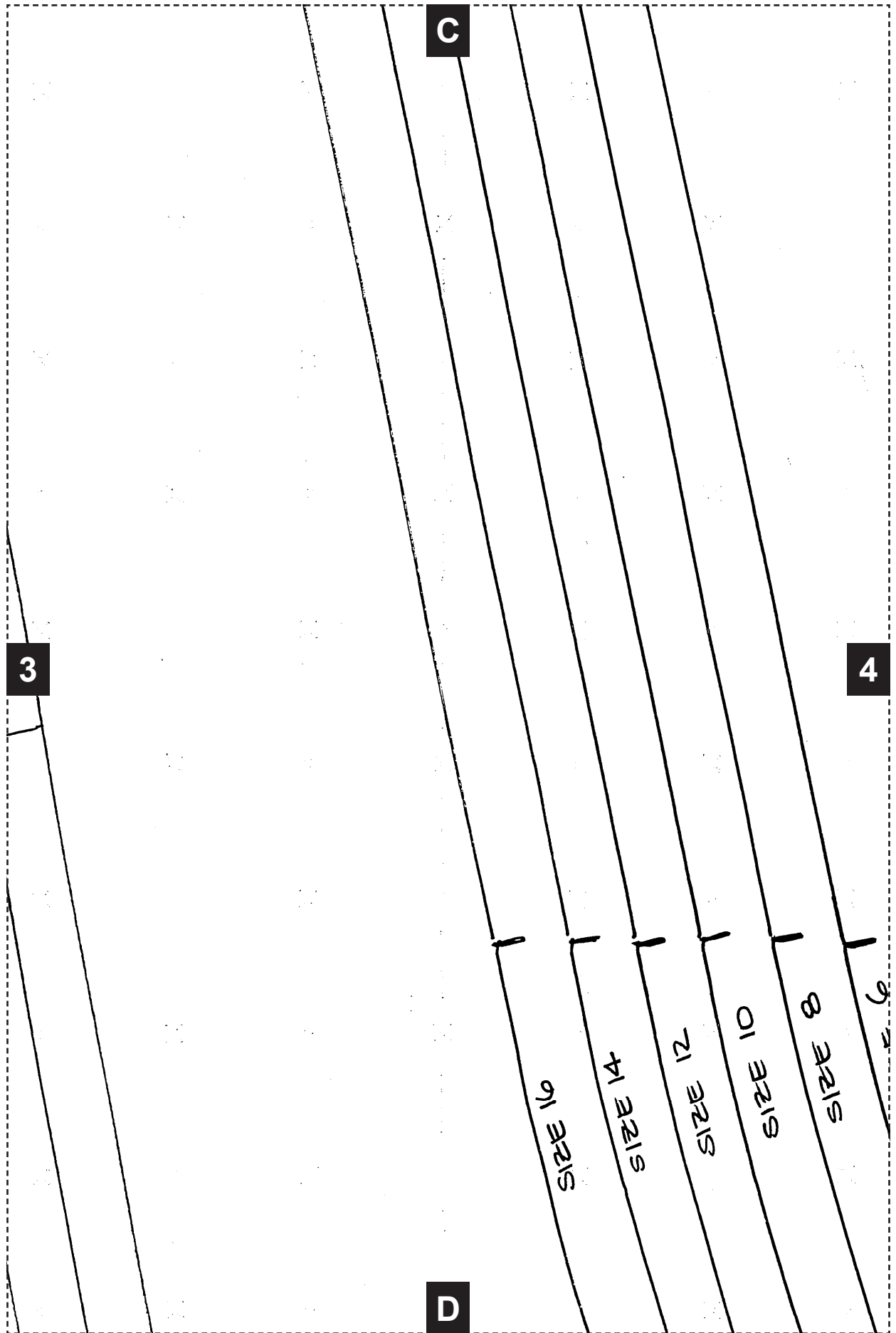

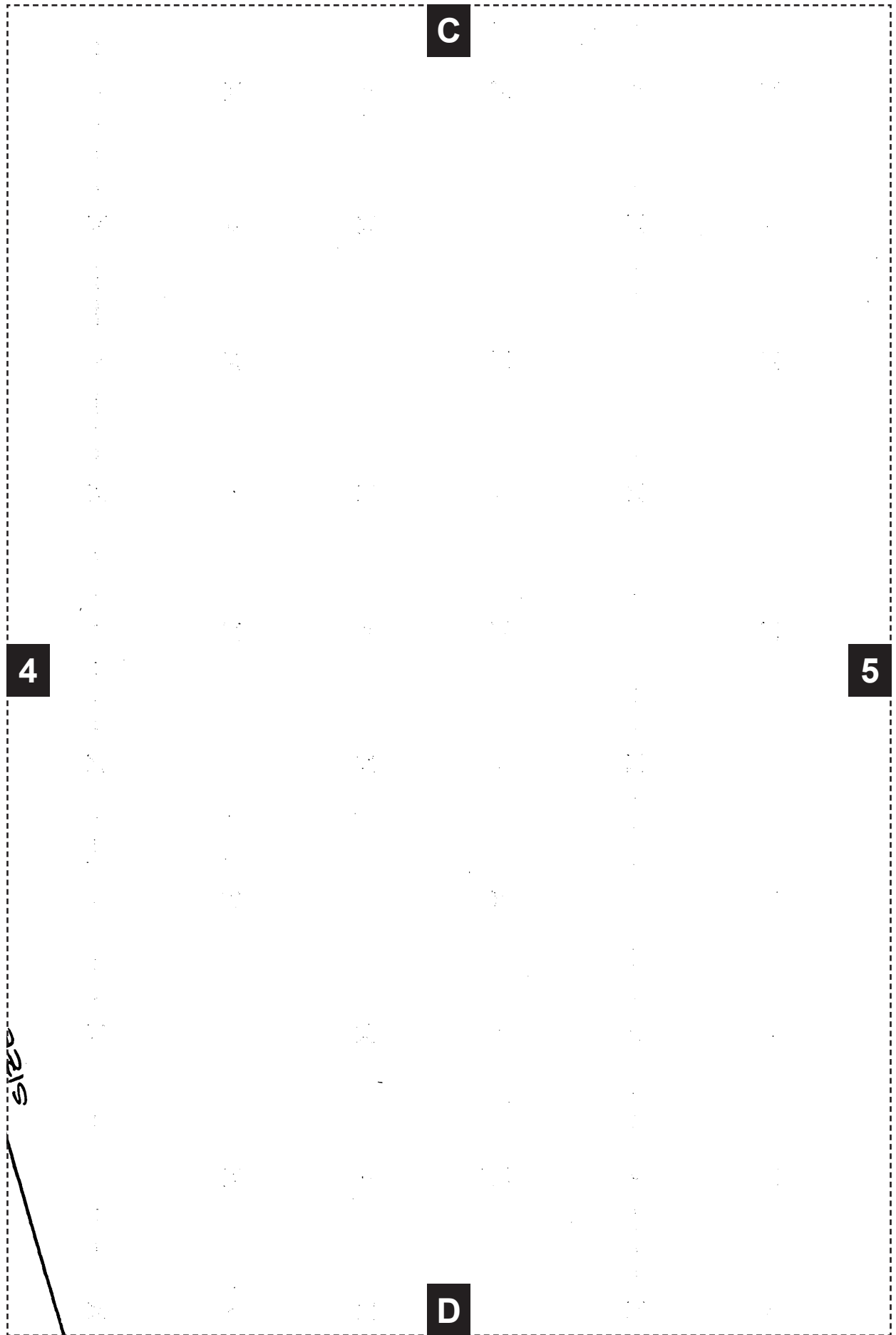

C

4

5

219

D

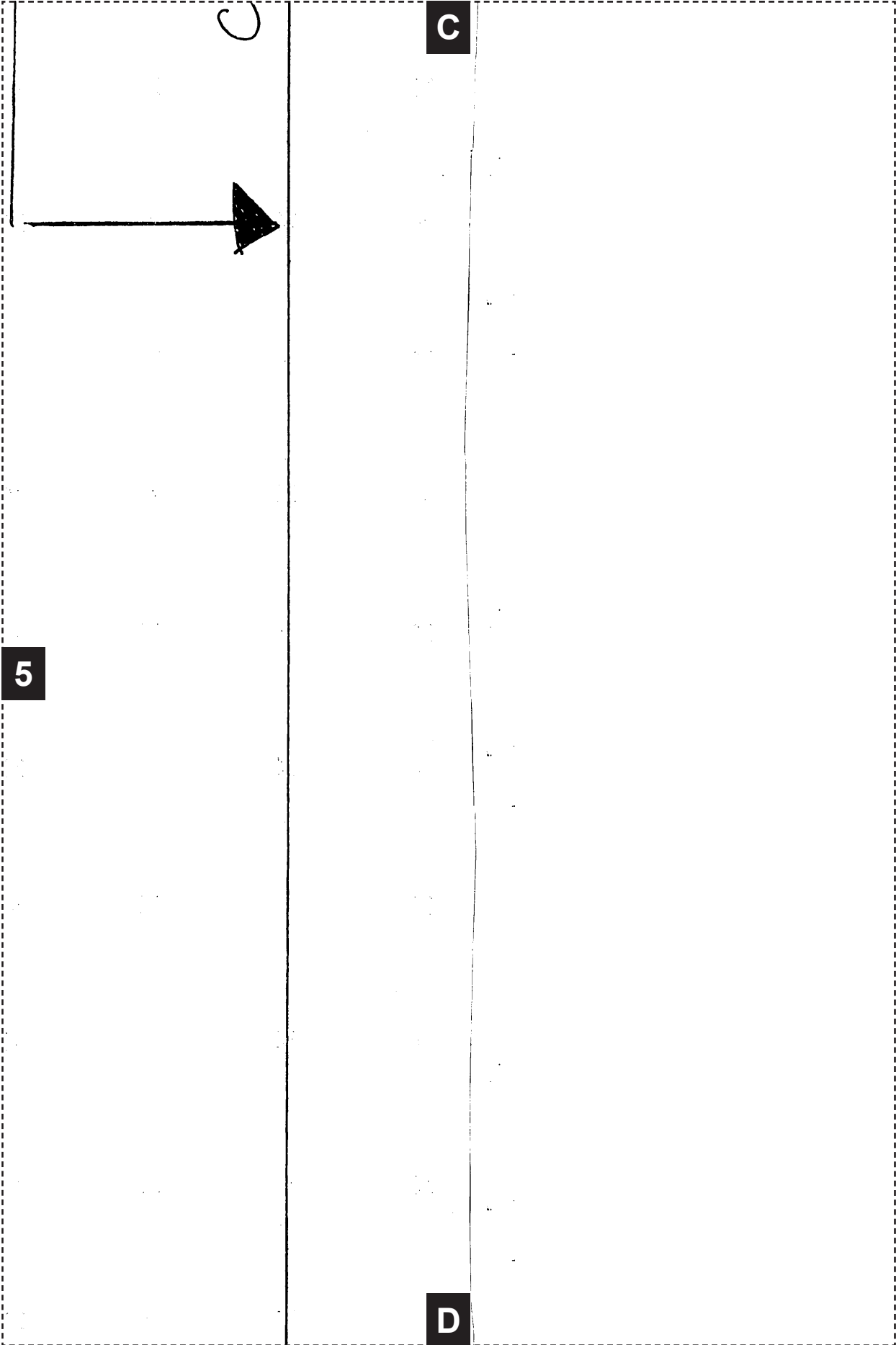

D

↓ cut

1

D

TO HERE FOR LONG LENGTH ↓

1

2

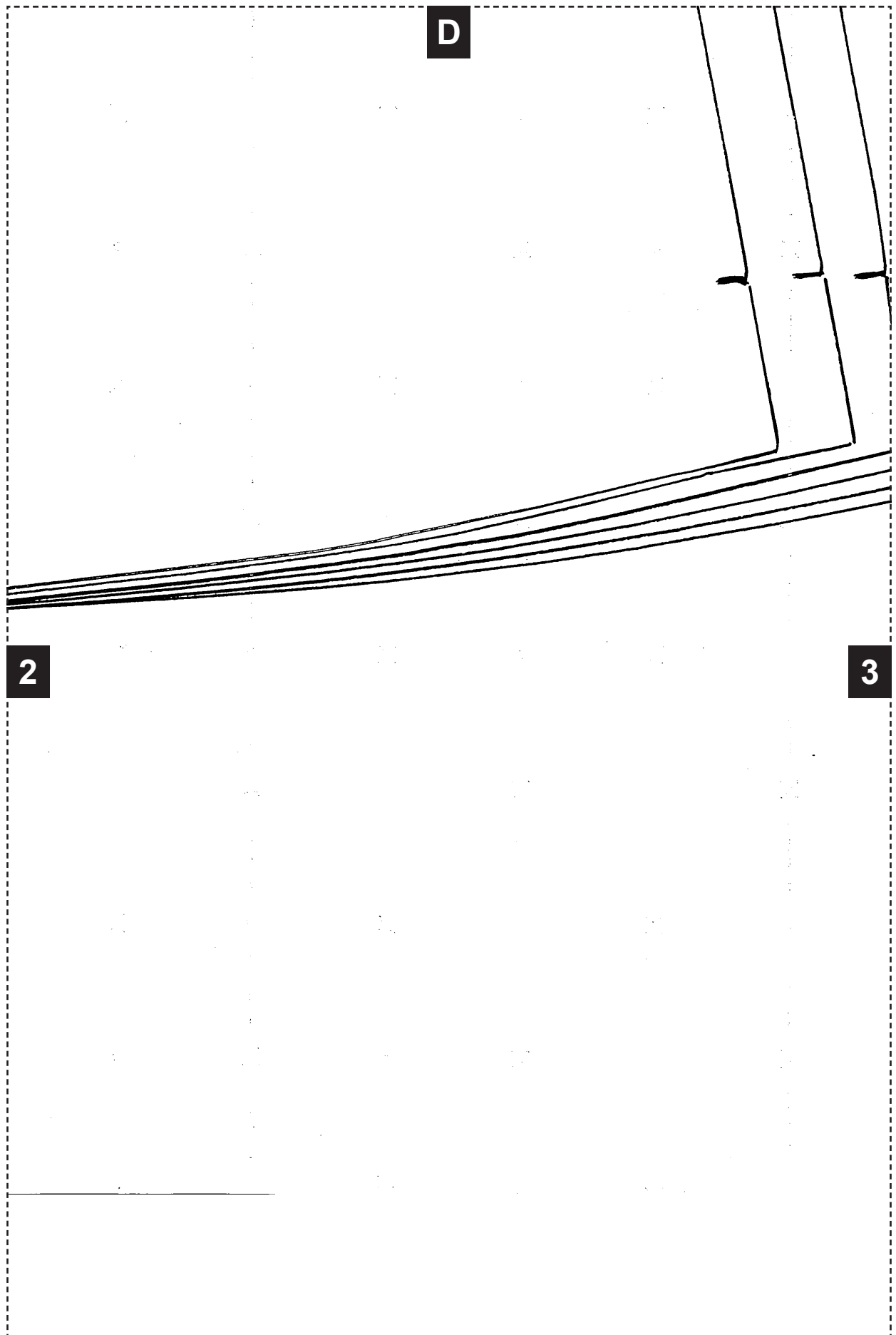

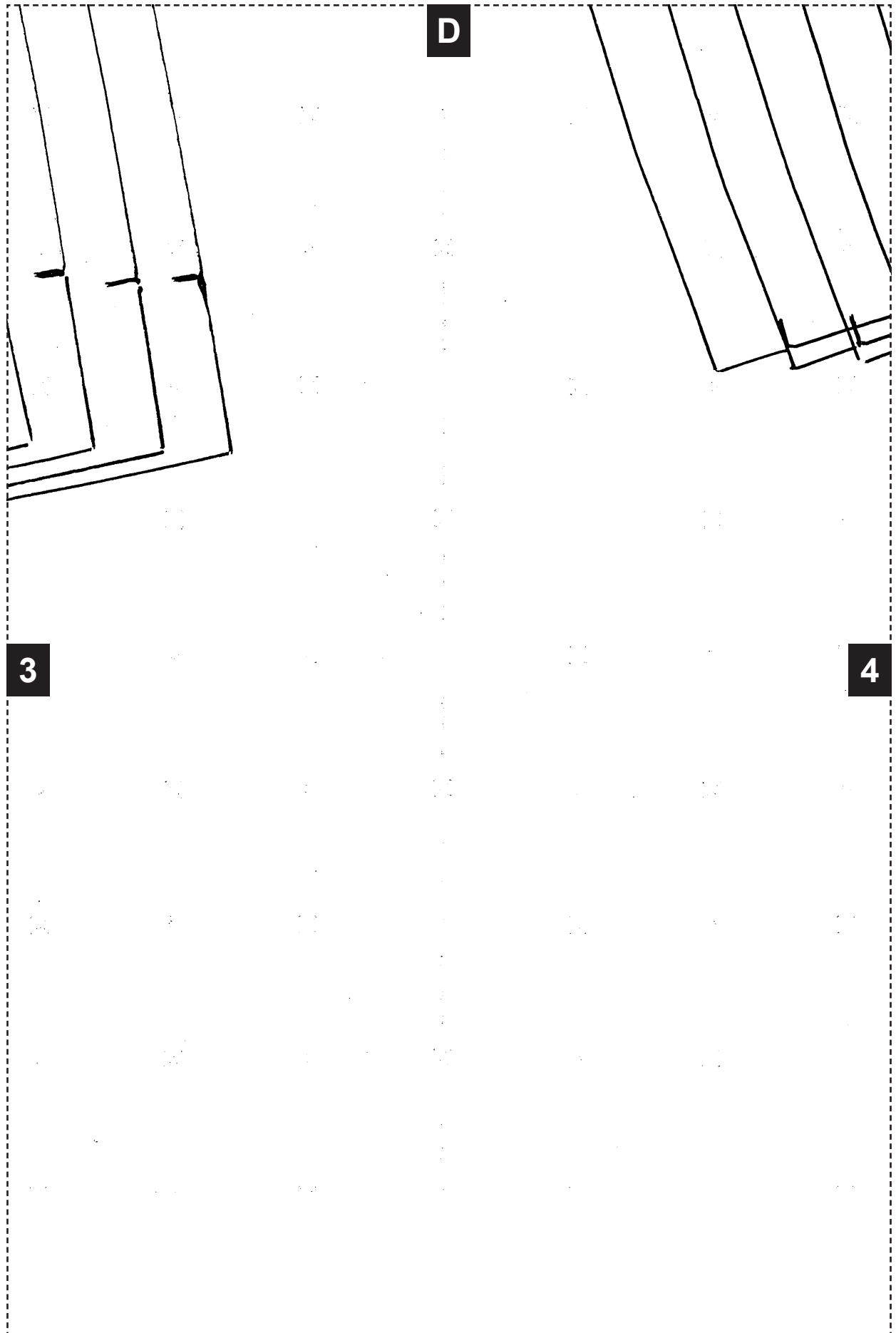

D

3

4

